



Venetian blind perfection. Direct action tilting, raising and lowering by means of new “slider” which keeps the blind tidy and elegant at all times.

16 mm slats in a multitude of colours and finishes.

New double weight closed bottom rail for improved hanging and appearance.



Patent no. 178192

## Options

**Control side**  
1100 Right  
1101 Left

**Control system <sup>1)</sup>**  
1209 Slider

**Fixation**  
1300 Swivel brackets  
1306 Extension brackets 6/10 cm  
1307 Extension brackets 14/17 cm

**Others**  
1904 Side guide  
1942 2 color combination  
1943 3 color combination  
1944 4 color combination  
1950 Side by side

## Properties

**Slat material** Crowned high tensile aluminium plain colors, special effects, perforated and printed

**Slat width** 16 mm

**Head rail** Roll formed steel painted 25 x 24 x 0.5 mm

**Bottom rail** Roll formed steel painted 19.5 x 10 x 0.5 mm

**Tilt wand** Aluminium 12 mm

**Ladder string** Polyester width 18 mm  
Distance between ladder rungs 13 mm

## Sundries

**<sup>1)</sup> Wand length**  
For drop > 200cm (drop:2)+15cm  
For drop < 200cm (drop:2)+B-180cm  
B=drop from the floor

**Color coordinated components**  
On request for projects

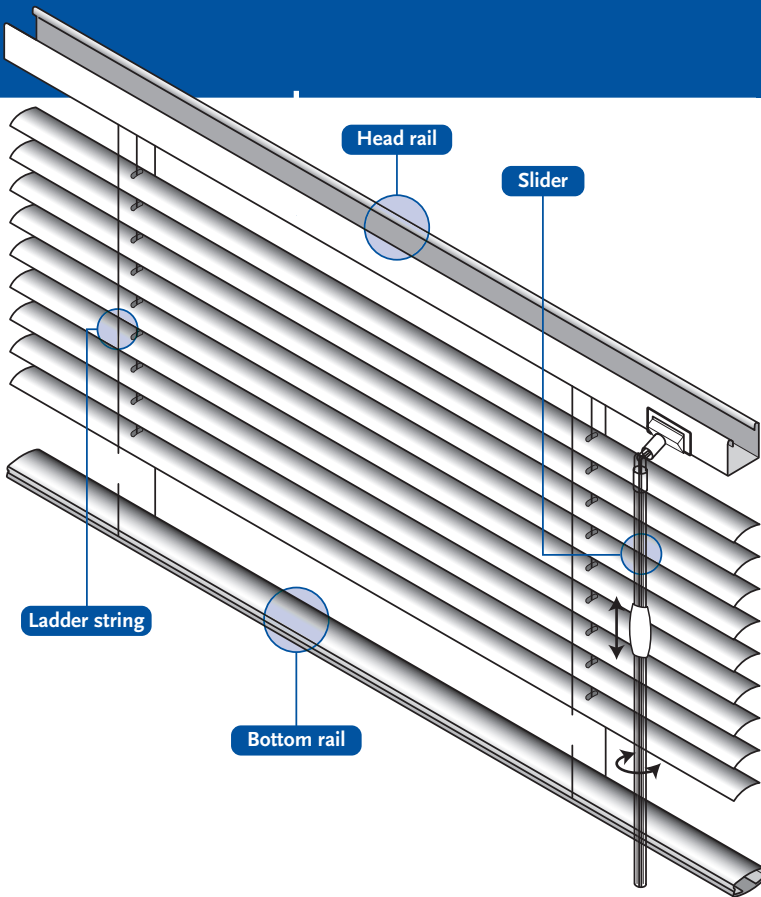

### General Topics System V13/16

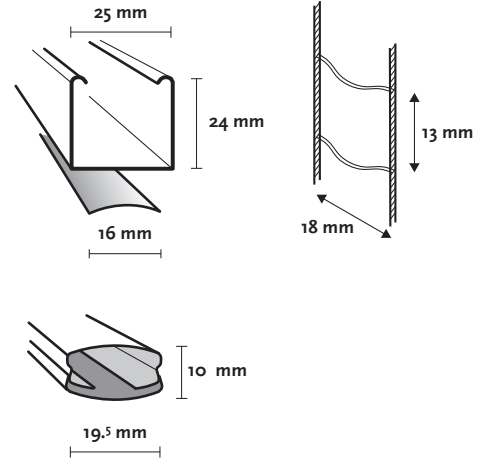

### Control options

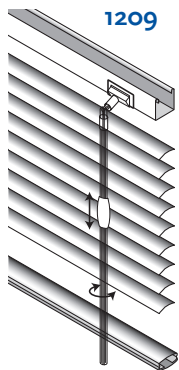

### Size restrictions

Control option	Sizes in cm			
	width	height	sq.m.	
1209	Max.	250	250	3,2
	Min.	45	20	0,09

### Fixation options

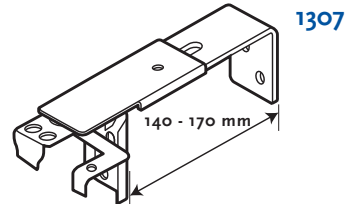
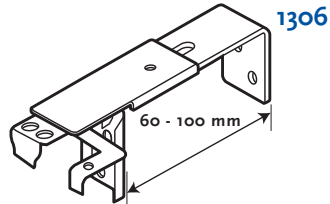
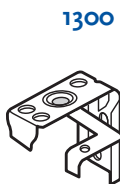

### Others

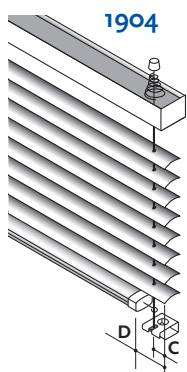

Sizes in mm	
C	D
15	27

### Stacking height

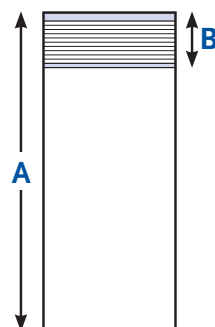

Sizes in mm	
Height (A)	Height (B)
500	55
1000	70
1500	85
2000	100
2500	115